



## **BUILT-IN GRILLS & COMPONENTS**

CREATE A 5-STAR MEAL IN YOUR OWN BACKYARD.

**EVERY.  
DE<sup>TA</sup>IL.  
MATTERS.**



**NO DETAIL  
TOO SMALL.**

# SEE THE DIFFERENCE A NAPOLEON MAKES.



At Napoleon, we understand that every detail matters. We know that even the smallest details add up to make a big difference when curating your perfect grilling experience.

# **PATENTED WAVE™ COOKING GRIDS.**

Our cooking grids are curved, not straight. Their unique shape provides enhanced durability and heat retention, plus they prevent food from falling through the cracks.

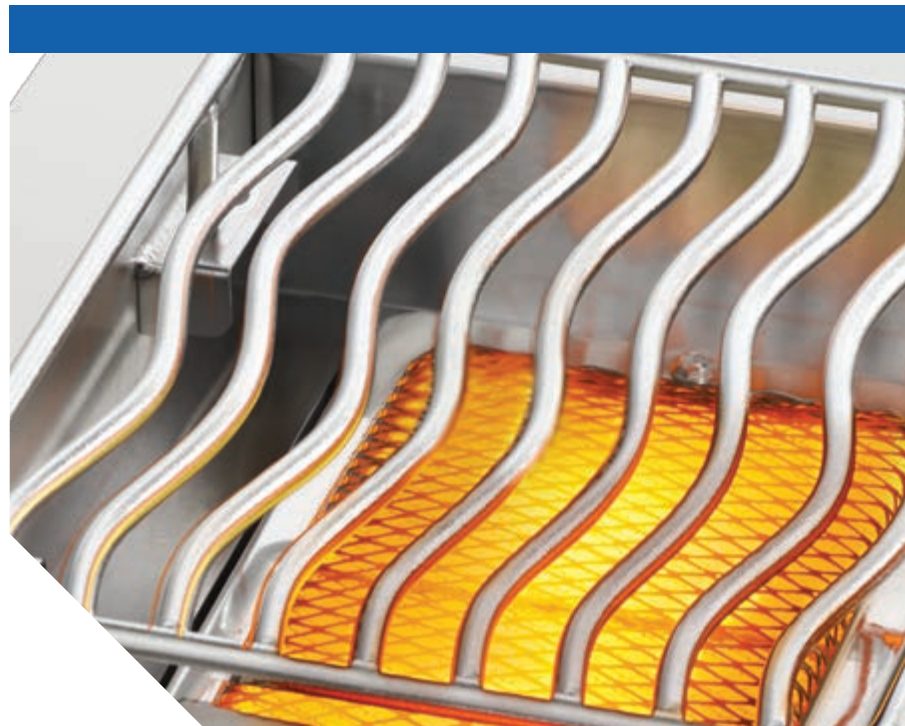



## **GET IN THE ZONE— THE SIZZLE ZONE®.**

Nothing but the best—experience Napoleon's custom-engineered infrared **SIZZLE ZONE®**. Our innovative infrared technology is capable of heating to an astounding 1800°F in only 30 seconds, for a steakhouse-quality sear in a snap.

# **NAPOLEON EXCLUSIVE— SAFETYGLOW™ KNOBS.**

Knobs that do so much more than just ignite the burners—they prioritize your safety. Our innovative knobs glow red when turned on, providing an instant visual cue.







# PRESTIGE® PRO 825

NATURAL GAS OR PROPANE  
**106k BTU**

COOKS UP TO  
**51 BURGERS\***

GRILL TO PERFECTION  
**6 BURNERS**



Propane BIPRO825RBIPSS-3  
Natural Gas BIPRO825RBINSS-3



Infrared **SIZZLE ZONE®**  
Bottom Burners



Integrated **Wood Chip Smoker** Tray



Rear **Infrared Rotisserie** Burner

Four-Fork **Rotisserie Kit** Included  
Cart Model Available

# PRESTIGE® PRO BIPRO825



LED Spectrum **NIGHT LIGHT™** Control Knobs  
With **SafetyGlow™**



Instant **Jetfire™** Ignition



**ACCU-PROBE™**  
Temperature Gauge



9.5 mm Stainless Steel  
**Iconic WAVE™**  
Cooking Grids

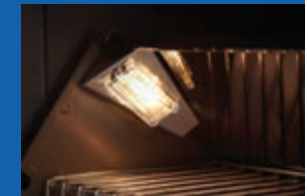

Interior **Halogen Grill** Lights



**Dual-Level Stainless Steel**  
Sear Plates

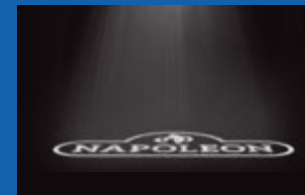

Proximity Lighting



**LIFT EASE™** Roll Top Lid

\*Grill capacity based on 4" burgers.

# 700 SERIES

BIG44 | BIG38 | BIG32



NIGHT LIGHT™ Control Knobs With **SafetyGlow™**



Instant **JETFIRE™** Ignition



ACCU-PROBE™ Temperature Gauge

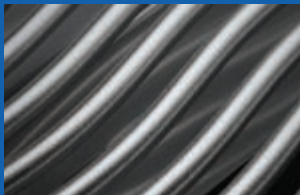

9.5mm Shot Blasted Stainless Steel **WAVE™** Cooking Grids

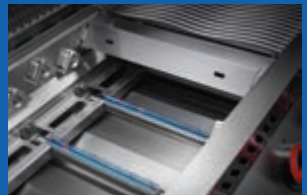

Dual-Level Stainless Steel Sear Plates



Trimless Design For Seamless Installation



Integrated Rotisserie Kit Storage



Dual-Level Stainless Steel Sear Plates

## BUILT-IN 700 SERIES 44"

NATURAL GAS OR PROPANE  
**108k BTU**

COOKS UP TO  
**46 BURGERS\***

GRILL TO PERFECTION  
**6 BURNERS**



Propane BIG44RBPSS-1 | Natural Gas BIG44RBNSS-1



Two Rear **Infrared Rotisserie** Burners



Two Dual-Level Warming Racks



Interior Halogen Grill Lights

1100 in<sup>2</sup> (7090 cm<sup>2</sup>) total cooking area  
Extended Flex Line  
Four-Fork **Rotisserie Kit** Included

\*Grill capacity based on 4" burgers.

## BUILT-IN 700 SERIES 38"

NATURAL GAS OR PROPANE  
**78k BTU**

COOKS UP TO  
**39 BURGERS\***

GRILL TO PERFECTION  
**5 BURNERS**



Propane BIG38BPSS-1 | Natural Gas BIG38RBNS-1



Rear **Infrared Rotisserie** Burner



Warming Rack



Interior Halogen Grill Lights

945 in<sup>2</sup> (6095 cm<sup>2</sup>) Total Cooking Area  
Two-Fork **Rotisserie Kit** Included

## BUILT-IN 700 SERIES 32"

NATURAL GAS OR PROPANE  
**66k BTU**

COOKS UP TO  
**32 BURGERS\***

GRILL TO PERFECTION  
**4 BURNERS**



Natural Gas BIG32RBNMK-1 ; BIG32RBNS-1  
Propane BIG32RBPMK-1 ; BIG32BPSS-1



Rear **Infrared Rotisserie** Burner



Warming Rack



Interior Halogen Grill Lights

785 in<sup>2</sup> (3385 cm<sup>2</sup>) Total Cooking Area  
Two-Fork **Rotisserie Kit** Included

\*Grill capacity based on 4" burgers.

## BUILT-IN 700 SERIES 32" FLAT-TOP GRIDDLE

NATURAL GAS OR PROPANE  
**24k BTU**

COOKS UP TO  
**28 BURGERS\***

GRILL TO PERFECTION  
**2 BURNERS**



Propane BIG32FTPSS | Natural Gas BIG32FTNSS

- Hassle-Free Grease Management System
- SafetyGlow™ Knobs with Flame Detection and Auto Gas Shutoff
- Dual-Zone Cooking
- Integrated Electronic Ignition
- 5mm Premium Stainless Steel Griddle
- Convenient Removeable Lid



\*Grill capacity based on 4" burgers.

# 500 SERIES

## BUILT-IN 500 SERIES 32"

NATURAL GAS OR PROPANE  
**48k BTU**

COOKS UP TO  
**32 BURGERS\***

GRILL TO PERFECTION  
**4 BURNERS**



Propane BI32PSS | Natural Gas BI32NSS

785 in<sup>2</sup> (3385 cm<sup>2</sup>) total cooking area



Robust Ergonomic  
Control Knobs



Instant JETFIRE™ Ignition



Dual-Level Stainless Steel  
Sear Plates



7.5 mm Stainless Steel Iconic  
WAVE™ Cooking Grids



ACCU-PROBE™  
Temperature Gauge

\*Grill capacity based on 4" burgers.

# BUILT-IN BURNERS

## 700 SERIES



### 18" DUAL INFRARED BURNER

BIB18IR

Propane BIB18IRPSS  
Natural Gas BIB18IRNSS

- 30,000 BTUs
- Infrared **SIZZLE ZONE**<sup>®</sup>
- Cooking area: 17.5" × 18"
- 9.5 mm shot-blasted stainless steel **Iconic WAVE**<sup>™</sup> cooking grids
- Stainless steel protective cover



### 18" POWER BURNER

BIB18PB

Propane BIB18PBSS  
Natural Gas BIB18PBNS

- 60,000 BTUs
- Inner ring burner: 25,000 BTU's
- Outer ring burner: 35,000 BTU's
- Dual-ring range burner for two-setting heat control
- Cooking Area: 17.5" × 18"
- 9.5 mm Stainless Steel Rod cooking grid with removable center ring for wok cooking
- Stainless steel protective cover



### 18" DUAL RANGE BURNER

BIB18RT

Propane BIB18RTPSS  
Natural Gas BIB18RTNSS

- 30,000 BTUs
- Dual-range burners
- Cooking area: 17.5" × 18"
- 9.5 mm Shot-Blasted Stainless Steel **Iconic WAVE**<sup>™</sup> cooking grids
- Stainless steel protective cover



### 12" INLINE DUAL RANGE BURNER

BIB12RT

Propane BIB12RTPSS  
Natural Gas BIB12RTNSS

- 30,000 BTUs
- Inline dual-range burners
- Cooking area: 11.5" × 18"
- 9.5 mm shot-blasted stainless steel **Iconic WAVE**<sup>™</sup> cooking grids
- Stainless steel protective cover

NOTE: To provide power to the 700 Series Burner NIGHT LIGHT<sup>™</sup> control knobs:  
N370-1091-SER - Power Supply Kit is required when a Built-in 700 Series burner is installed without connecting to a Built-in 700 Series Grill.  
N750-0087 - 3ft Extension Wire is required if a Built-in 700 Series burner is installed beyond 3ft of a Built-in 700 Series Grill.

## 700 SERIES



### 10" SINGLE INFRARED DROP-IN BURNER

#### BIB10IR

Propane BIB10IRPSS | BIB10IRPMK  
Natural Gas BIB10IRNSS | BIB10IRNMK

- 10,000 BTUs
- Infrared **SIZZLE ZONE**<sup>®</sup>
- Cooking Area: 9" × 10.5"
- 7.5 mm Shot-Blasted Stainless Steel **Iconic WAVE**<sup>™</sup> cooking grids
- Stainless steel protective cover



### 10" SINGLE-RANGE DROP-IN BURNER

#### BIB10RT

Propane BIB10RTPSS  
Natural Gas BIB10RTNSS

- 10,000 BTUs
- Single Range Burner
- Cooking Area: 9" × 10.5"
- Stainless steel protective cover
- 7.5 mm Shot-Blasted Stainless Steel **Iconic WAVE**<sup>™</sup> cooking grids
- Stainless steel protective cover

## 500 SERIES



### 12" INLINE DUAL- RANGE BURNER

#### BI12RT

Propane BI12RTPSS  
Natural Gas BI12RTNSS

- 30,000 BTUs
- Dual Inline Range Burners
- Cooking Area: 11.75" × 18"
- 7.5 mm Shot-Blasted Stainless Steel **Iconic WAVE**<sup>™</sup> cooking grids
- Stainless Steel Protective Cover



### 10" SINGLE-RANGE BURNER

#### BI10RT

Propane BI10RTPSS  
Natural Gas BI10RTNSS

- 10,000 BTUs
- Single Range Burner
- Cooking Area: 9" × 10.5"
- 7.5 mm Shot-lasted Stainless Steel **Iconic WAVE**<sup>™</sup> cooking grids
- Stainless Steel Protective Cover

# BUILT-IN COMPONENTS



**42" X 24" SINGLE DOOR & TRIPLE DRAWER**

BI-4224-1D3DR



**42" X 24" SINGLE DOOR & DOUBLE DRAWER**

BI-4224-1D2DR



**42" X 24" SINGLE DOOR & WASTE BIN DRAWER AND PAPER TOWEL HOLDER**

BI-4224-1D1W



**36" X 24" SINGLE DOOR & TRIPLE DRAWER**

BI-3624-1D3DR



**36" X 24" SINGLE DOOR & DOUBLE DRAWER**

BI-3624-1D2DR



**36" X 24" SINGLE DOOR & WASTE BIN DRAWER AND PAPER TOWEL HOLDER**

BI-3624-1D1W



**18" X 24" DOUBLE DRAWER**

BI-1824-2DR



**18" X 24" TRIPLE DRAWER**

BI-1824-3DR



**18" X 24" WASTE BIN DRAWER AND PAPER TOWEL HOLDER**

BI-1824-1W



**18" X 16" DOUBLE DRAWER**

BI-1816-2DR



**18" X 24" REVERSIBLE SINGLE DOOR**

BI-1824-1DR



**42" X 8" SINGLE DRAWER**

BI-4208-1DR



**18" X 8" SINGLE DRAWER**

BI-1808-1DR



**36" X 24" DOUBLE DOOR**

BI-3624-2D



**30" X 24" DOUBLE DOOR**

BI-3024-2D



**18" X 24" SINGLE DOOR**

BI-1824-1D



**18" X 16" SINGLE DRAWER**

BI-1816-1DR



**SLIDE-OUT PROPANE TANK KIT**

BI-TSK



**BEVERAGE CENTER**

BI-2418-BEV

Stainless steel construction

Seamless trim provides versatile and flawless installation

Soft closing doors and drawers

Used for more versatile installation in a wide range of materials and finishes

## UNDER GRILL CABINETS AND DRAWERS



### 42" X 16" SINGLE DOOR & DOUBLE DRAWER

**DESIGNED FOR:**  
Built-in 44" Grill (BIG44RB)

BI-4216-1D2DR



### 36" X 16" SINGLE DOOR & DOUBLE DRAWER CABINET

**DESIGNED FOR:**  
Built-in 38" Grill (BIG38RB)

BI-3616-1D2DR



### 42" X 16" DOUBLE DOOR

**DESIGNED FOR:**  
Built-in 44" Grill (BIG44RB)

BI-4216-2D



### 36" X 16" SMALL DOUBLE DOOR

**DESIGNED FOR:**  
Built-in 38" Grill (BIG38RB)

BI-3616-2D



### 30" X 16" DOUBLE DOOR

**DESIGNED FOR:**  
Built-in 32" Grill (BIG32RB)

BI-3016-2D



### 18" X 16" SINGLE DRAWER

BI-1816-1DR

### 18" X 16" SINGLE DOOR

BI-1816-1D

## ZERO CLEARANCE LINERS



### 44" ZERO CLEARANCE LINER

**DESIGNED FOR:**  
Built-In 44" Grill (BIG44RB)

BI-4823-ZCL



### 38" ZERO CLEARANCE LINER

**DESIGNED FOR:**  
Built-In 38" Grill (BIG38RB)

BI-4223-ZCL



### 32" ZERO CLEARANCE LINER

**DESIGNED FOR:**  
Built-In 32" Grill (BIG32RB / BI32)

BI-3623-ZCL



### 18" ZERO CLEARANCE LINER

**DESIGNED FOR:**  
Built-In 18" Burners (BIB18IR | BIB18RT | BIB18PB)

BI-2423-ZCL

Expand design horizons with zero clearance liners allowing for more finishing material options on your custom outdoor kitchen. Each is constructed of 304 grade stainless steel and feature integrated balancing brackets.

## CUSTOMIZE

Many options of door and drawer components, propane tank slider kits and zero clearance liners. The sleek stainless steel components complement any design.



BI-4224-1D1W shown: 42" x 24" large door & waste bin drawer and paper towel holder

# OASIS® MODULAR ISLANDS

Personalize your outdoor living space

Choose the modules that fit your lifestyle and your budget. The cabinets can be assembled in virtually any combination to suit your individual needs. All cabinets are 35 ½" tall and 24" deep with 4 leveling feet for easy adjustment on any surface. The Oasis® Outdoor Modular Island series can be assembled against any non-combustible wall of your home or as a standalone island.



# PLAN YOUR OASIS®

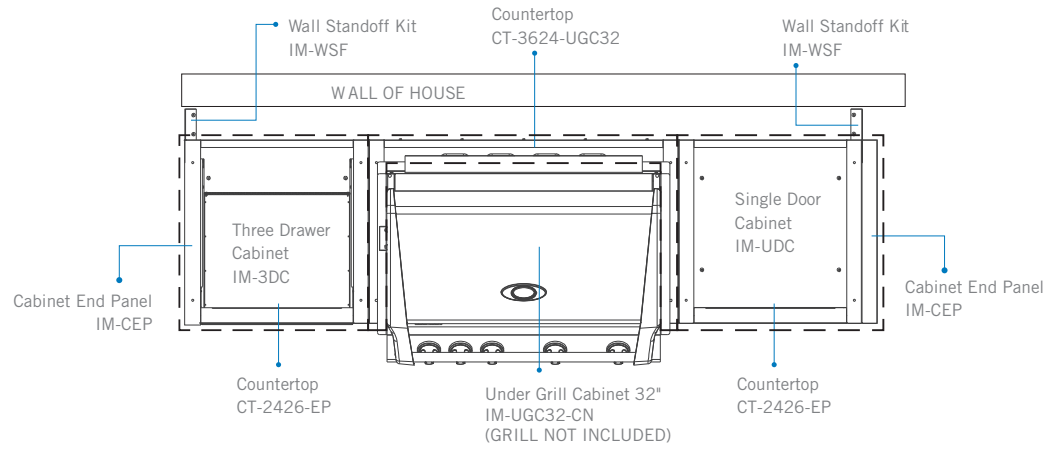

## SELECT YOUR GRILL



## SELECT YOUR CABINETS



## SELECT YOUR COUNTERTOP



# OASIS® MODULAR ISLAND COMPONENTS

## UNDER GRILL CABINETS

Precision-crafted cabinets designed to perfectly fit our grill heads and drop-in burners.



### PRESTIGE® PRO 825 UNDER GRILL CABINET

BIPRO825RBI.....IM-UGC825-MK-1

### 44" BUILT-IN UNDER GRILL CABINET

BIG44RB.....IM-UGC44-MK-1

### 38" BUILT-IN UNDER GRILL CABINET

BIG38RB.....IM-UGC38-MK-1

### 32" BUILT-IN UNDER GRILL CABINET

BIG32RB | BI32 .....IM-UGC32-MK-1

### 18" BUILT-IN BURNER UNDER GRILL CABINET

BIB18IR | BIB18RT | BIB18PB ..IM-UGC18-MK-1

### FOR IM-UGC18-MK:

IM-UGC12TK-MK Trim Kit required when installing BIB12RT & BI12RT

The countertop\* material must be non-combustible if a grill is to be installed into it. They can be ordered in advance by drawing out the floor plan of how the cabinets will be situated and adding up the width measurements, allowing 1-2" of countertop overhang. Most countertop manufacturers are willing to come and take measurements after assembly of the cabinets is complete to ensure a perfect fit. For best results the countertop thickness should be between ¾" to 1 ½" thick. The built-in grill comes with stainless steel brackets and hardware that allow the unit to rest on the countertop above the corresponding island cabinet for that unit. Granite is an excellent choice of countertop materials. Decorative countertops made of ceramic tile set on top of cement tiling board can be selected to match your surrounding backyard furniture color. \*If Napoleon Stainless Steel Countertops are not selected the countertops must be supplied locally by the homeowner.

# DRAWERS, ACCESSORIES, TRANSITIONS

Precision-crafted components to complete your dream kitchen.



**THREE-DRAWER CABINET**  
IM-3DC-MK-1



**TWO-DRAWER CABINET**  
IM-WDC-MK-1



**WASTE DRAWER WITH PAPER TOWEL HOLDER**  
IM-WDC-MK-1



**PROPANE TANK OR UNIVERSAL CABINETS**  
IM-DRC-MK-1,  
IM-PTC-MK-1-NA (Shown)  
Left or right opening



**OUTDOOR-RATED STAINLESS STEEL FRIDGE**  
NFR0550USS-1



**45° CABINET TRANSITIONS**  
**DESIGNED FOR:**  
Any cabinet on a 45-degree transition without a grill or burner  
IM-45T-MK = 45°



**45° LARGE TRANSITION**  
**DESIGNED FOR:**  
Any grill or burner on 45-degree transition  
IM-45LT-MK



**WALL SPACER**  
IM-WSF-MK



**CABINET END PANEL**  
IM-CEP-MK



**FRIDGE END PANEL**  
**DESIGNED FOR:**  
Any grill or burner on 45-degree transition  
IM-1DFEP-MK



**FRIDGE MID PANEL**  
IM-1DFMP-MK

# STAINLESS STEEL COUNTERTOPS

The finishing touch, engineered to last.



**24" X 24" COUNTERTOP**  
CT-2424

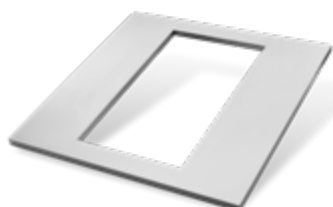

**24" X 24" COUNTERTOP,  
BIB10 CUTOUT**  
CT-2424-BIB10



**24" X 26" COUNTERTOP  
END PIECE**  
CT-2426-EP

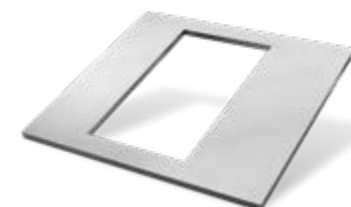

**24" X 26" COUNTERTOP,  
BIB10 CUTOUT END PIECE**  
CT-2426-BIB10-EP

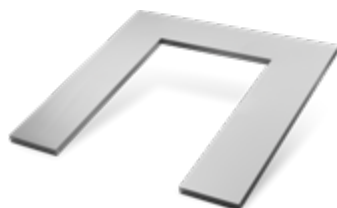

**24" X 24" COUNTERTOP,  
BIB12 CUTOUT**  
CT-2424-BIB12

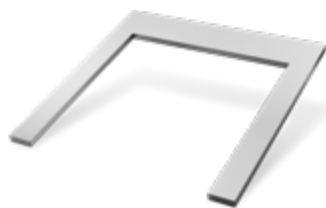

**24" X 24" COUNTERTOP,  
BIB18 CUTOUT**  
CT-2424-UGC18



**36" X 24" COUNTERTOP,  
UGC32**  
CT-3624-UGC32



**42" X 24" COUNTERTOP,  
UGC38**  
CT-4224-UGC38



**48" X 24" COUNTERTOP,  
UGC44**  
CT-4824-UGC44



**36" X 24" WATERFALL  
END PANEL**  
CT-WFCEP

\*Must be installed at any end configuration where an under grill cabinet is positioned at the end of the kitchen. IM-UGC44-MK-1 | IM-UGC38-MK-1 | IM-UGC32-MK-1 | IM-UGC18-MK-1



## **FROM COMPONENTS TO COMPLETE KITCHEN**

Pair precision-crafted cabinetry, seamless stainless steel surfaces, and high-performance cooking to create a fully integrated outdoor experience.

# CONFIGURATION INSPIRATION

## BUILT-IN 500 SERIES 32" GRILL

NATURAL GAS OR PROPANE  
**48k BTU**

COOKS UP TO  
**32 BURGERS\***

GRILL TO PERFECTION  
**4 BURNERS**



BI32PSS | BI32NSS



All components sold separately.

Create this configuration using the below components:

- 500 Series 32" grill
- IM-UGC32-MK-1
- IM-3DC-MK-1
- IM-DRC-MK-1  
(IM-PTC-MK-1-NA Propane Tank Cabinet if designing with a propane grill)
- 2x IM-CEP-MK
- CT-3624-UGC32 & CT-2426-EP x2  
Stainless Steel Countertops

### FEATURES



Dual-level **Stainless Steel** Sear Plates



7.5 mm Stainless Steel **Iconic WAVE™** Cooking Grids



**Instant JETFIRE™** Ignition



Robust **Ergonomic** Control Knobs

# CONFIGURATION INSPIRATION

## BUILT-IN 700 SERIES 32" FLAT-TOP GRIDDLE

NATURAL GAS OR PROPANE  
**24k BTU**

COOKS UP TO  
**28 BURGERS\***

GRILL TO PERFECTION  
**2 BURNERS**



All components sold separately.



BIG32FTNSS | BIG32FTPSS



Create this configuration using  
the below components:

- 700 Series 32" griddle
- IM-UGC32-MK-1
- IM-DRC-MK-1  
(IM-PTC-MK-1-NA Propane Tank Cabinet if  
designing with a propane grill)
- CT-3624-UGC32 & CT-2424 & CT-WFCEP  
Stainless Steel Countertops

### FEATURES



**SafetyGlow™** Knobs  
with Flame Detection  
and Auto Gas Shutoff



**Dual-Zone** Cooking

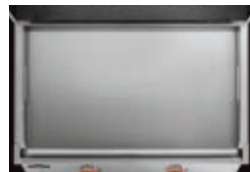

5mm Premium **Stainless  
Steel** Griddle



Integrated  
**Electronic Ignition**

# OASIS<sup>®</sup> COMPACT SERIES

The ultimate solution for a complete outdoor kitchen.



Napoleon OASIS<sup>®</sup> Compact series has been developed with versatility in mind.

# OASIS® OUTDOOR KITCHEN KIT

## BUILT-IN 700 SERIES 32"

NATURAL GAS OR PROPANE  
**76k BTU**

COOKS UP TO  
**32 BURGERS\***

GRILL TO PERFECTION  
**4 BURNERS**



Natural Gas OOK-001 | Propane OOK-002

Complete kit with all components and appliances.



Includes:

- 700 Series 32" grill
- 10" single infrared side burner
- Waste drawer cabinet
- Designated 32" under grill cabinet
- Single door cabinet (propane tank cabinet if propane sku is ordered)
- Two cabinet end panels
- CT-2426-EP, CT-3624-UGC32 & CT-2426-BIB10-EP  
Stainless Steel Countertops

### FEATURES



**NIGHT LIGHT™**  
Control Knobs with  
**SafetyGlow™**



9.5mm Stainless  
Steel **Iconic WAVE™**  
Cooking Grids



Rear **Infrared**  
**Rotisserie** Burner with  
Rotisserie Kit



**Instant JETFIRE™**  
Ignition

# ESSENTIAL PROTECTION

High-quality covers designed for our Prestige® PRO, and Built-in 700 & 500 Series Grills and Burners

## GRILL COVERS



### PRESTIGE® PRO 825 BUILT-IN GRILL COVER

BIPRO825RBI..... 61826

### BUILT-IN 44" GRILL COVER

BIG44RB..... 61842

### BUILT-IN 38" GRILL COVER

BIG38RB..... 61836

### BUILT-IN 32" GRILL COVER

BIG32RB & BI32..... 61830

### BUILT-IN GRIDDLE COVER

BIG32FT..... 61831

## BURNER COVERS



### BUILT-IN 10" SIDE BURNER COVER

(BIB10IR, BIB10RT & B110RT)

61810



### BUILT-IN 12" SIDE BURNER COVER

(BIB12IR, BIB12RT & B112RT)

61812



### BUILT-IN 18" SIDE BURNER COVER

(BIB18PB, BIB18IR & BIB18RT)

61818

# COMPATIBLE ACCESSORIES

Must-have accessories designed to fit all Built-In Series Grills

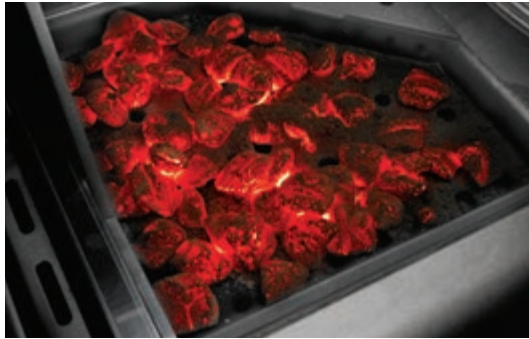

**CAST IRON CHARCOAL AND SMOKER TRAY**  
67732



**HIGH-POWERED LED GRILL LIGHT**  
70049

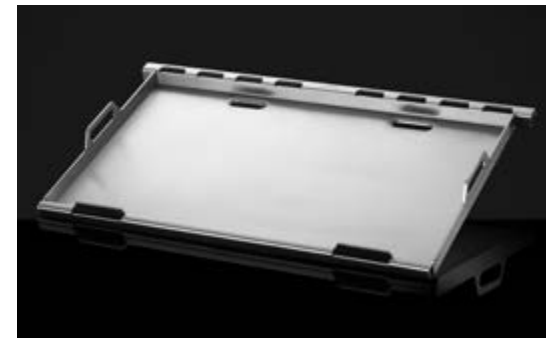

**STAINLESS STEEL GRIDDLE INSERT**  
56094



**STAINLESS STEEL SMOKER BOX**  
67013



**ROTISSERIE SHISH-KEBAB SKEWER SET  
WITH REMOVABLE SKEWERS**  
64008



**ROTISSERIE GRILL BASKET**  
64000



## **COMPLETE YOUR OUTDOOR EXPERIENCE**

Grilling isn't just for one season anymore. With the Timberwolf® Smokeless Fire Pit and Phantom Freestand Electric Heater, you can keep the heat - and the good times - going all year long. Designed to complement your built-in grill with matching finishes and modern design, these additions bring style, comfort, and more time outdoors.



## PHANTOM FREESTAND ELECTRIC HEATER

Heat Where You Want It. When You Want It.

- Electric Infrared Heater for focused and efficient heat, allowing for extended use of outdoor space across multiple seasons
- Outdoor rated materials and powder coated for superior durability
- Up to 1500W output with odorless heat
- Standard household 120V (15 AMP), requiring no expensive installation
- Heats up to 144 sq. ft.
- 8-foot cord and wheels for seamless portability
- Built-in safety features include anti-tipping and over-heat automatic shut off
- Offers a clean alternative to propane heaters, eliminating the need for refueling
- Up to 5,000 BTUs
- Warranty: 2 Years



Light-up Knob with 9 Heat & Timer Settings



Sleek Matte Black Finish



Four-position Adjustable Arm for Targeted Warmth

NEOFV80IH

# TIMBERWOLF® SMOKELESS FIRE PIT

Portable. Durable. Made for Any Adventure.

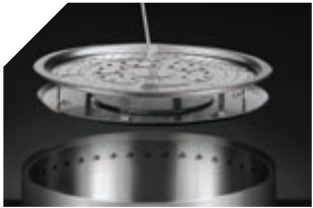

Removable Ash Pan



Spark Screen



Base Ring



Cover



Poker



Carry Handle



Fuel with Wood, Pellets or Charcoal for Cooking



NWFPMTI-SS | NWFPMTI-PHM: 17 ½" height, 18" diameter  
NWFPMTI-SS (Not shown): 17 ½" height, 22" diameter





# ELEVATE YOUR SMOKELESS FIRE PIT EXPERIENCE



NWO44TI-BK

NWO20TI-BK

## ROUND FIRE PIT SURROUND AND SIDE TABLE

- Built-in space to store wood and all accessories
- Adds a safety barrier and usable surface area
- Surround compatible with both 18" and 22" models
- Covers sold separately

\*These products are sold separately

# SPECIFICATIONS

DOORS, DRAWERS & ACCESSORIES (opening size for installation)	Part Number	Width in. (cm)	Depth in. (cm)	Height in. (cm)
18" x 8" Single Drawer	BI-1808-1DR	18 5/8 (47)	22 3/4 (58)	8 3/4 (22)
18" x 16" Single Drawer	BI-1816-1DR	18 5/8 (47)	22 3/4 (58)	16 3/4 (43)
18" x 16" Double Drawer	BI-1816-2DR	18 5/8 (47)	22 3/4 (58)	16 3/4 (43)
18" x 16" Double Door	BI-1816-2D	18 5/8 (47)	3 (8)	16 3/4 (43)
18" x 24" Reversible Single Door	BI-1824-1D	18 5/8 (47)	3 (8)	24 3/4 (63)
18" x 24" Waste Bin Drawer	BI-1824-1W	18 5/8 (47)	22 3/4 (58)	24 3/4 (63)
18" x 24" Double Drawer	BI-1824-2DR	18 5/8 (47)	22 3/4 (58)	24 3/4 (63)
18" x 24" Triple Drawer	BI-1824-3DR	18 5/8 (47)	22 3/4 (58)	24 3/4 (63)
Beverage Center	BI-2418-BEV	24" (61)	18 (46)	10 1/2 (27)
30" x 24" Double Door	BI-3024-2D	30 1/2 (77)	3 (8)	24 3/4 (63)
36" x 16" Double Door	BI-3616-2D	36 1/2 (93)	3 (8)	16 3/4 (43)
30" x 16" Double Door	BI-3016-2D	30 1/2 (78)	3 (8)	16 3/4 (43)
36" x 16" Single Door & Double Drawer	BI-3616-1D2DR	36 1/2 (93)	22 3/4 (58)	16 3/4 (43)
36" x 24" Door & Waste Bin Combo	BI-3624-1D1W	36 1/2 (93)	22 3/4 (58)	24 3/4 (63)
36" x 24" Door & Double Drawer Combo	BI-3624-1D2DR	36 1/2 (93)	22 3/4 (58)	24 3/4 (63)
36" x 24" Door & Triple Drawer Combo	BI-3624-1D3DR	36 1/2 (93)	22 3/4 (58)	24 3/4 (63)
36" x 24" Double Door	BI-3624-2D	36 1/2 (93)	3 (8)	24 3/4 (63)
42" x 8" Single Drawer	BI-4208-1DR	42 1/2 (108)	22 3/4 (58)	8 3/4 (22)
42" x 16" Double Door	BI-4216-2D	42 1/2 (108)	3 (8)	16 3/4 (43)
42" x 16" Single Door & Double Drawer	BI-4216-1D2DR	42 1/2 (108)	22 3/4 (58)	16 3/4 (43)
42" x 24" Door & Waste Bin Combo	BI-4224-1D1W	42 1/2 (108)	22 3/4 (58)	24 3/4 (63)
42" x 24" Door & Double Drawer Combo	BI-4224-1D2DR	42 1/2 (108)	22 3/4 (58)	24 3/4 (63)
42" x 24" Door & Triple Drawer Combo	BI-4224-1D3DR	42 1/2 (108)	22 3/4 (58)	24 3/4 (63)
33" x 23" Zero Clearance Liner	BI-3323-ZCL	32 7/8 (83.5)	22 9/16 (57)	9 1/16 (23)
46" Zero Clearance Liner	BI-4823-ZCL	46 (117)	21 3/8 (54)	10 3/8 (26)
40" Zero Clearance Liner	BI-4223-ZCL	40 (101)	21 3/8 (54)	10 3/8 (26)
34" Zero Clearance Liner	BI-3623-ZCL	34 (86)	21 3/8 (54)	10 3/8 (26)
22" Zero Clearance Liner	BI-2423-ZCL	22 (56)	21 3/8 (54)	10 3/8 (26)
Slide Out Propane Tank Kit	BI-TSK	15 (38)	20 (51)	24 (61)
OASIS® MODULAR COMPONENTS	Part Number	Width in. (cm)	Depth in. (cm)	Height in. (cm)
Under Grill Cabinet - 825 series	IM-UGC825-MK	55 (139)	24 (61)	35 1/2 (90)
Under Grill Cabinet - 665 series	IM-UGC665-MK	40 1/2 (103)	24 (61)	35 1/2 (90)
Under Grill Cabinet - 500 series	IM-UGC500-MK	34 3/4 (88)	24 (61)	35 1/2 (90)
Under Grill Cabinet - 700 Series BIG 44RB	IM-UGC44-MK	46 3/4 (114)	24 (61)	35 1/2 (90)
Under Grill Cabinet - 700 Series BIG38RB	IM-UGC38-MK	40 3/4 (104)	24 (61)	35 1/2 (90)
Under Grill Cabinet - 500 Series BIG32RB / BIG32	IM-UCG32-MK	34 3/4 (88)	24 (61)	35 1/2 (90)
Under Grill Cabinet BIB18RT / BIB18IR / BIB18PB	IM-UGC18-MK**	24 (61)	24 (61)	35 1/2 (90)

S = Standard O = Optional \* Rear burner \* All lid openings require a minimum of 5" clearance behind the unit.

\*\* IM-UGC12TK-MK Trim Kit required when installing BIB12RT & BI12RT. Refer to owners manual for individual models.

Dimensions subject to change. Refer to manual for accurate dimensions.

Important: Always refer to manual for individual models. Dimensions shown here are rounded for approximation - Dimensions subject to change. Refer to manual for accurate dimensions. Refer to manual for end panels and transition kits not shown here.

OASIS® MODULAR COMPONENTS						
	Part Number	Width in. (cm)	Depth in. (cm)	Height in. (cm)		
Propane tank cabinet - universal door	IM-PTC-MK-1-NA	24 (61)	24 (61)	35 ½ (90)		
Universal door cabinet	IM-DRC-MK-1	24 (61)	24 (61)	35 ½ (90)		
Outdoor rated fridge	NFR055OUSS-1	24 (61)	26 (66)	34 (86)		
Three drawer cabinet	IM-3DC-MK-1	24 (61)	24 (61)	35 ½ (90)		
Two drawer cabinet	IM-2DC-MK-1	24 (61)	24 (61)	35 ½ (90)		
Waste drawer with paper towel holder	IM-WDC-MK-1	24 (61)	24 (61)	35 ½ (90)		
Wall spacer	IM-WSF-MK	1 ½ (4)	4 (10)	35 (89)		
GRILL/GRIDDLE SPECIFICATIONS						
	BIPRO825RBI	BIG44RB	BIG38RB	BIG32RB	BI32	BIG32FT
Double walled stainless steel lid	S	S	S	S	S	-
Detachable Lid	-	-	-	-	-	S
Interconnected lighting knobs (Controls lights from each grill and burner)	-	S	S	S	S	-
Interior lights	S	S	S	S	-	-
Built-in trim with 2" Cut-out Tolerance	-	S	S	S	S	-
Convertible valves	-	S	S	S	S	-
GRILL/GRIDDLE DIMENSIONS (opening size for installation)						
Total width in Inches (cm)	52 ¾ (133)	42-44 (107-111)	36-38 (92-96)	30-32 (77 - 81)	30-32 (77 - 81)	30-32 (77 - 81)
Total depth in Inches (cm)	20 ⅝ (52)	19 ⅝ - 19 ¾ (49 - 50)	19 ⅝ - 19 ¾ (49 - 50)	19 ⅝ - 19 ¾ (49 - 50)	19 ⅝ - 19 ¾ (49 - 50)	19 ⅝ - 19 ¾ (49 - 50)
Total height in Inches (cm)	8 ⅞ (23)	10 ¼ (26)	10 ¼ (26)	10 ¼ (26)	10 ¼ (26)	10 ¼ (26)
OASIS® STAINLESS STEEL COUNTERTOPS						
	Part Number	Width in. (cm)	Depth	height		
Universal stainless steel countertop	CT-2424	24 (61)	24 (61)	.75 (2)		
Stainless steel countertop with 10" burner cutout	CT-2424-BIB10	24 (61)	24 (61)	.75 (2)		
Stainless steel end countertop	CT-2426-EP	26 (66)	24 (61)	.75 (2)		
Stainless steel end countertop with 10" burner cutout	CT-2426-BIB10-EP	26 (66)	24 (61)	.75 (2)		
Stainless steel countertop with 12" burner cutout	CT-2424-BIB12	24 (61)	24 (61)	.75 (2)		
Stainless steel countertop with 18" burner cutout	CT-2424-UGC18	24 (61)	24 (61)	.75 (2)		
Stainless steel countertop for 32" built-in grill and under grill cabinet	CT-3624-UGC32	36 (91)	24 (61)	.75 (2)		
Stainless steel countertop for 38" grill head	CT-4224-UGC38	42 (106)	24 (61)	.75 (2)		
Stainless steel countertop for 44" grill head	CT-4824-UGC44	48 (121)	24 (61)	.75 (2)		
Stainless steel end panel for waterfall edge	CT-WFCEP	36 (91)	24 (61)	.75 (2)		



[napoleon.com](http://napoleon.com)

24 Napoleon Road, Barrie, Ontario, L4M 0G8  
103 Miller Drive, Crittenden, Kentucky, USA 41030  
7200 Trans Canada Highway, Montreal, Quebec H4T 1A3

PHONE: 1-888-721-8324



Follow us on social  
[@napoleonproducts](https://www.instagram.com/napoleonproducts)

Authorized Dealer

Approved by Intertek Testing Services to standards in the USA and Canada: ANSI Z21.58 / CSA 1.6 - Outdoor Cooking Gas Appliances.  
All specifications and designs are subject to change without prior notice due to ongoing product improvements. Consult your owner's manual for complete installation and operating instructions and check all local and national Building Codes and Regulations. Not all features available on all models. Images and colors may not be exactly as shown. Napoleon is a trademark of Wolf Steel Group Inc. and is used under license.



Printed in Canada  
ADBRN2-BIGG-3